

BPI621 0B

# Brandt



MANUEL D'INSTRUCTION FR  
INSTRUCTION MANUAL EN  
MANUAL DE INSTRUCCIONES ES  
BEDIENUNGSHANDBUCH DE  
BRUGSVEJLEDNING DA  
NÁVOD K POUŽITÍ CZ  
MANUAL DE INSTRUÇÕES PT

Table de cuisson  
Cooking Hob  
Placa de cocción  
Kochfeld  
Kogeplade  
Varná deska  
Placa de cozinha

1

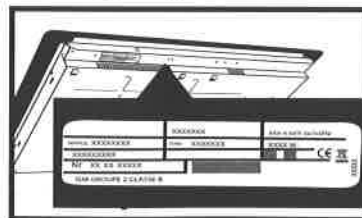

1.1

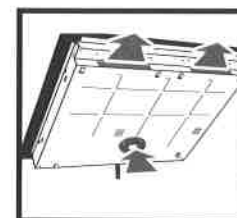

1.2

1.2.1

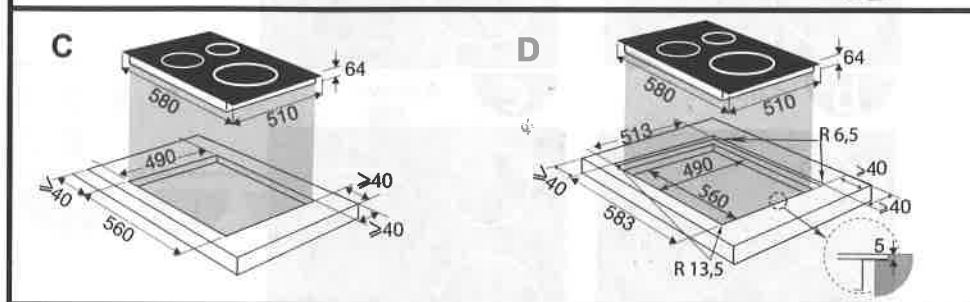
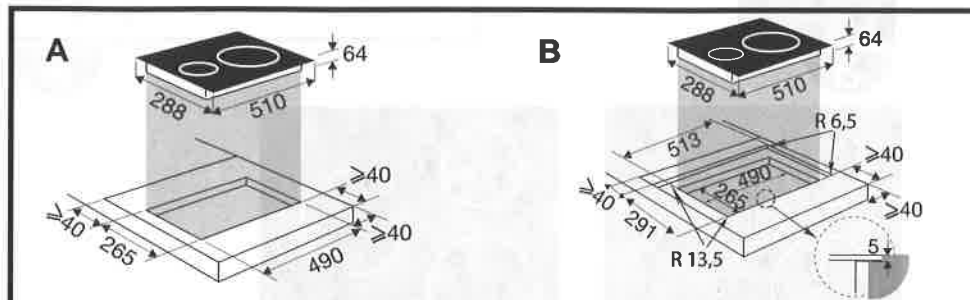

1.2.2

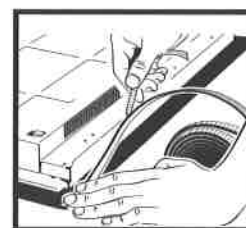

1.2.3

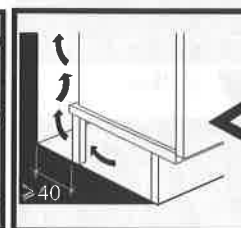

1.2.4

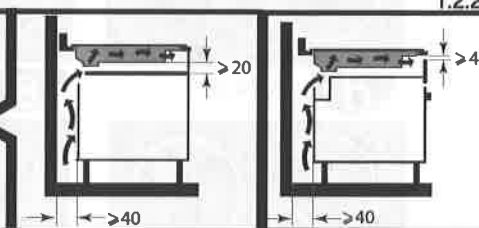

1.2.5

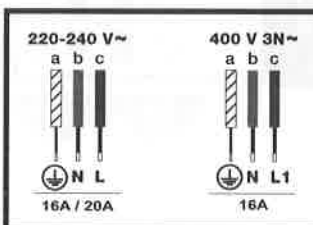

1.3

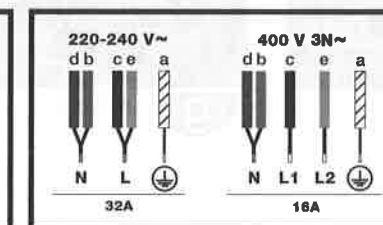

1.3.1

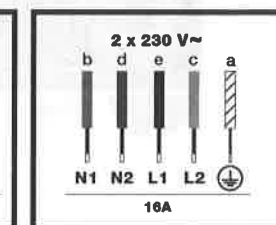

1.3.2

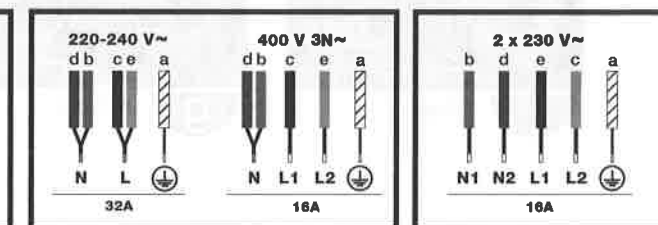

1.3.3

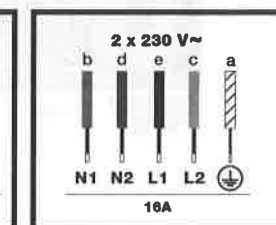

1.3.3



a 3,6kw

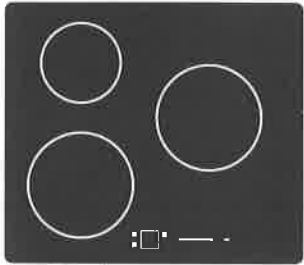

b 3,6kw

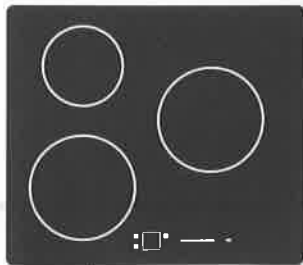

c 4,6kw

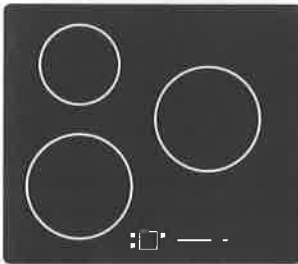

d 6,7kw

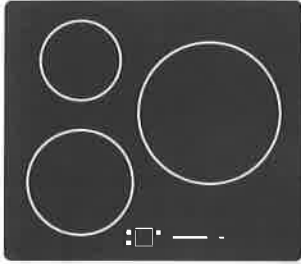

e 7,2kw

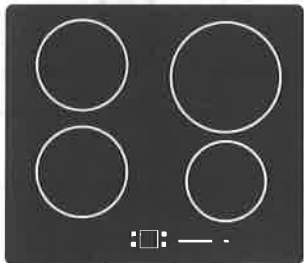

f 3kw

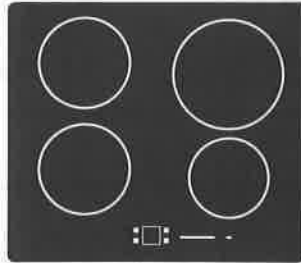

g 4,6kw



a



b c d e

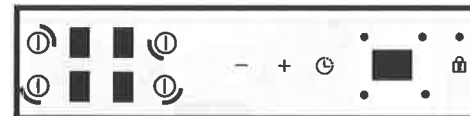

f g

# 3

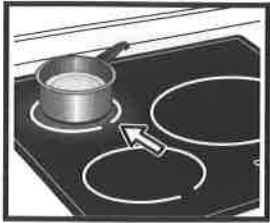

3.1

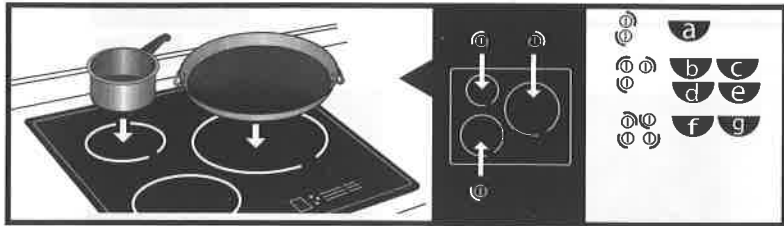

3.2

3.2.1

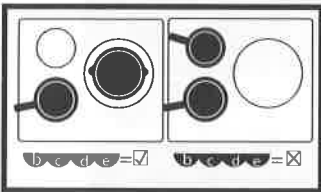

3.2.2

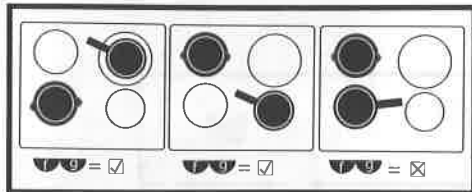

3.2.3

# 4

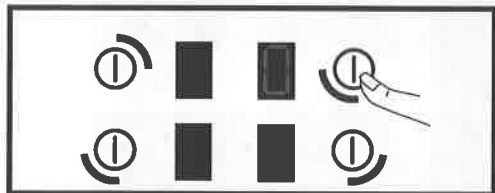

4.1

4.1.1

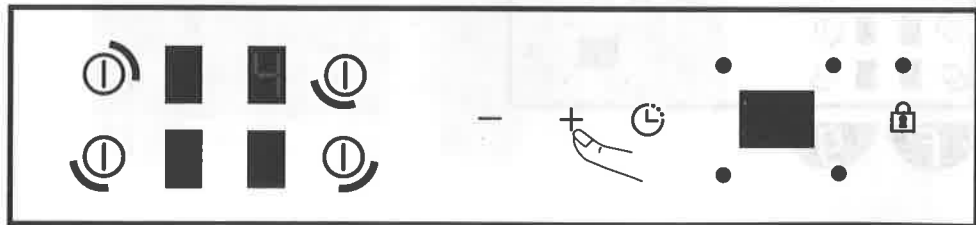

4.2

4.2.1

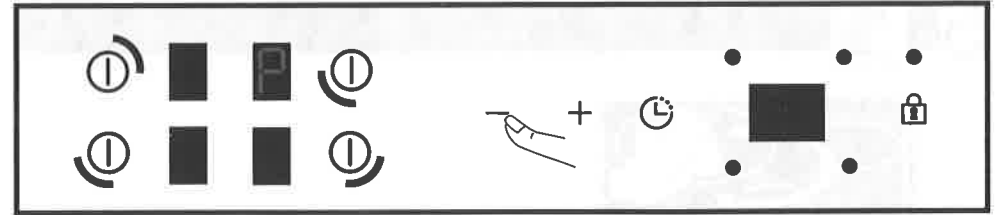

4.2.2

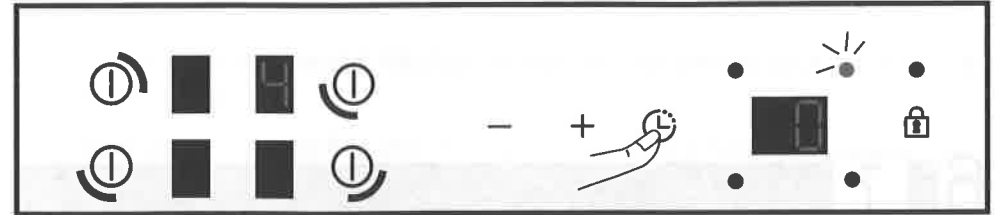

4.3

4.3.1

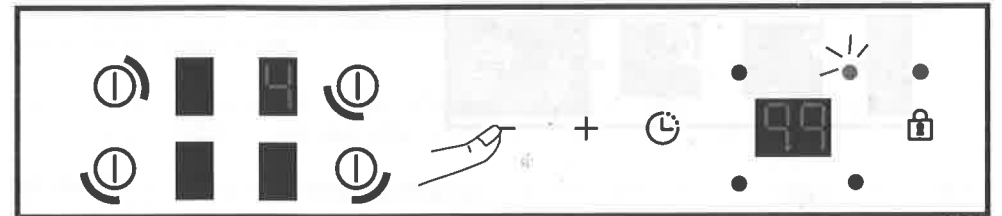

4.3.2

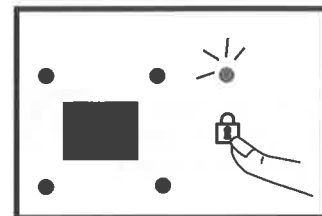

4.4

4.4.1

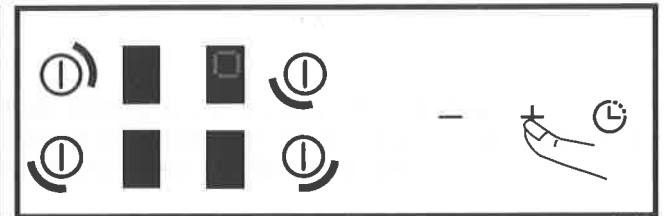

4.4.2

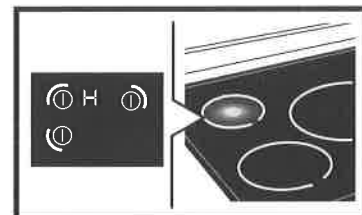

4.5

4.5.1

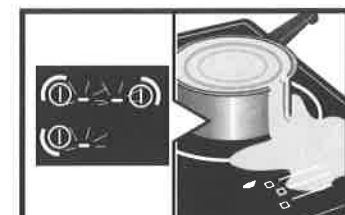

4.5.2



4.5.3

5 6 

Chère Cliente, Cher Client,

Vous venez d'acquérir un produit **BRANDT** et nous vous remercions de la confiance que vous nous accordez.

Nous avons conçu et fabriqué ce produit en pensant à vous, à votre mode de vie, à vos besoins, pour qu'il réponde au mieux à vos attentes. Nous y avons mis notre savoir-faire, notre esprit d'innovation et toute la passion qui nous anime depuis plus de 60 ans.

Dans un souci permanent de toujours mieux satisfaire vos exigences, notre service consommateurs est à votre disposition et à votre écoute pour répondre à toutes vos questions ou suggestions.

Connectez-vous aussi sur notre site [www.brandt.com](http://www.brandt.com) où vous trouverez nos dernières innovations, ainsi que des informations utiles et complémentaires.

**BRANDT** est heureux de vous accompagner au quotidien et vous souhaite de profiter pleinement de votre achat.



**Important : Avant de mettre votre appareil en marche, veuillez lire attentivement ce guide d'installation et d'utilisation afin de vous familiariser plus rapidement avec son fonctionnement.**



### Protection de l'environnement

Ce symbole indique que cet appareil ne doit pas être traité comme un déchet ménager.

Votre appareil contient de nombreux matériaux recyclables. Il est donc marqué de ce symbole afin de vous indiquer que les appareils usagés doivent être remis à un point de collecte habilité.

Renseignez-vous auprès de votre revendeur ou des services techniques de votre ville pour connaître les points de collecte des appareils usagés les plus proches de votre domicile. Le recyclage des appareils qu'organise votre fabricant sera ainsi réalisé dans les meilleures conditions, conformément à la directive européenne sur les déchets d'équipements électriques et électroniques.

Certains matériaux d'emballage de cet appareil sont également recyclables. Participez à leur recyclage et contribuez ainsi à la protection de l'environnement en les déposant dans les conteneurs prévus à cet effet.

Nous vous remercions pour votre collaboration à la protection de l'environnement.



### RELATIONS CONSOMMATEURS FRANCE

Pour en savoir plus sur nos produits ou nous contacter, vous pouvez:

> consulter notre site : [www.brandt.com](http://www.brandt.com)

> nous écrire à l'adresse postale suivante :

Service Consommateurs BRANDT  
5 avenue des Béthunes  
CS69526 SAINT OUEN L'AUMONE  
95060 CERGY PONTOISE CEDEX

> nous appeler du lundi au vendredi de 8h30 à 18h00 au :

**0 892 02 88 01** Service 0,50 € / min  
+ prix appel

Service fourni par Brandt France, S.A.S. au capital social de 100.000.000 euros. RCS Nanterre 801 250 531.

### INTERVENTIONS

Les éventuelles interventions sur votre appareil doivent être effectuées par un professionnel qualifié dépositaire de la marque. Lors de votre appel, afin de faciliter la prise en charge de votre demande, munissez-vous des références complètes de votre appareil (référence commerciale, référence service, numéro de série). Ces renseignements figurent sur la plaque signalétique.

Vous pouvez nous contacter du lundi au samedi de 8h00 à 20h00 au :

**09 69 39 25 25** Service gratuit  
+ prix appel

### PIÈCES D'ORIGINE

Lors d'une intervention, demandez l'utilisation exclusive de pièces détachées certifiées d'origine.



Dear Customer,

You have just acquired a **BRANDT** product and we would like to thank you.

We have designed and made this product with you, your lifestyle and your requirements in mind so that it meets your expectations. We have devoted our know-how, our innovative spirit and the passion that has been guiding us for over 60 years.

In an effort to ensure that our products meet your requirements in the best possible way, our Customer Relations department is at your disposal, to answer all your questions and to listen to all your suggestions.

Visit our website [www.brandt.com](http://www.brandt.com) where you will find our latest innovations, as well as useful and complementary information.

**BRANDT** is delighted to assist you every day and hopes you get the most out of your purchase.



**Important: Before using your appliance, read this user guide carefully to familiarise yourself more quickly with its operation.**



## Safety instructions

### **IMPORTANT SAFETY INSTRUCTIONS TO BE READ CAREFULLY AND KEPT FOR FUTURE USE.**

This guide can be downloaded from the brand web site.

This appliance can be used by children over 8 years old and persons with reduced physical, sensory or mental capabilities or without experience and knowledge if they have been correctly informed or trained in the use of the appliance in a safe way and understand the hazards involved.

Children must not play with the appliance.

Children must not clean and maintain the appliance without supervision.

Children under 8 years old must be kept away from the hob unless they are supervised at all times.

The appliance and its accessible parts become hot during use.

Precautions must be taken to avoid touching the heating elements.

Metal objects such as knives, forks, spoons and lids must not be placed on the cooking surface as they may heat up.

Your hob is equipped with a child safety device that locks its operation after use or during cooking (See "Child Safety use" section).

Your appliance complies with applicable European Directives and regulations.

In order to avoid interference between your cooking hob and a pacemaker, the pacemaker must be designed and programmed in compliance with the regulations that apply to it. Ask the pacemaker manufacturer or your GP.

Leaving oil or fat to heat unattended on a hob may be dangerous and lead to fire. NEVER attempt to extinguish a fire with water. Instead, switch off the appliance, then cover the flame with a lid or a fire blanket.

**CAUTION:** cooking must be monitored. Quick heating must be monitored at all times.

Danger of fire: do not store objects on the cooking areas.

If the surface is cracked, disconnect the appliance to avoid the risk of electric shock.

Do not use your hob until you have replaced the glass worktop.

Avoid hard shocks from cookware: although the vitroceramic glass worktop is very sturdy, it is not unbreakable.

Do not place any hot lids flat on your cooking hob. A suction effect may damage the vitroceramic surface. Avoid



## Safety instructions

dragging cookware across the surface, which may in the long-term result in the degradation of the decorative finish of the vitroceramic top.

Never use a sheet of aluminium for cooking. Never place items wrapped in aluminium foil or packaged in aluminium dishes on your cooking hob. The aluminium will melt and permanently damage your appliance.

Do not store cleaning products or flammable products in the cabinet underneath your cooking hob.

If the power cable is damaged, it should be replaced by the manufacturer, its after-sales service department or a similarly qualified person to avoid danger. Ensure that the power cables of any electrical appliances plugged in close to the hob are not in contact with the cooking zones.

Never use a steam cleaner to clean your cooking hob.

The appliance is not designed to be switched on using an external timer or a separate remote control system.

**WARNING:** Only use hob protectors designed by the manufacturer of the cooking appliance or listed as suitable in the user guide, or included with the appliance. Use of unsuitable protectors could cause accidents.

1



### 1.1 UNPACKING

For future use, remove all protective elements. Check and respect the appliance's characteristics that appear on the nameplate.

Note in the boxes below the service and standard references shown on this plate.

### 1.2 FITTING INTO THE WORK TOP

Service :	Type :
Puissance totale :	

Check that the air intake and outlet are free of obstruction (1.2.1).

For standard fitting, refer to diagrams A or C.

For flush-fitting, refer to diagrams B or D.

Comply with the information concerning the fitting dimensions (in millimetres) of the work top destined to receive the hob (1.2.2). Glue the sealing joint to the entire surround of the hob (depending on model) (1.2.3), before fitting. Check that air circulates correctly between the front and the back of your hob.

If you are installing the hob above a drawer (1.2.4) or above a built-in oven (1.2.5), comply with the dimensions provided on the illustrations to ensure a sufficient air outlet at the front.

If your hob is located above your oven, the hob's thermal safety devices can impede the simultaneous use of the hob and the oven's pyrolysis programme, display code "F7" in the control zones. In such circumstances we recommend that you increase the hob's ventilation by creating an opening in the side of the cabinet (8 x 5 cm).

### 1.3 ELECTRIC CONNECTIONS

These hobs must be connected to the power grid via an all-pole cut-off device that complies with installation regulations in effect. A disconnection device must be incorporated into the fixed wiring.

Identify the type of cable of your hob according to the number of wires and colours:

- 3-wire cable (1.3.1):

a) green-yellow, b) blue, c) brown.

- 5-wire cable (1.3.2 and 1.3.3):

a) green-yellow, b) blue, c) brown, d) black,

e) grey.

When switching your hob on or after a lengthy power cut, a code is shown on the control pad (this display is reserved for your after-sales service, where applicable. The user of the hob does not need to take notice of it).

This information disappears after around 30 seconds.

2



Identify your type of hob

by comparing the number and arrangement of burners, the type of keypad and the total power of your appliance using the illustrations with the nameplate.

3



### 3.1 CHOICE OF COOKWARE

Cookware with the symbol are compatible with induction.

We suggest that you choose cookware with a thick and flat bottom. The heat will be distributed better and cooking will be more uniform.

Advice on how to save energy: Cooking with the correctly sized lid saves energy. If you use a glass lid, you can control your cooking perfectly.

### 3.2 BURNER SELECTION

Select the burner which is the right size for the bottom of your cookware (see table). If the base or the cookware is too small, the power indicator will start to flash and the burner will not work, even if the cookware's material is recommended for induction.

Diameter of burner	Hob model	Maximum power of burner (Watts)	Diameter of bottom of cookware
16 cm		2000	10 to 18 cm
18 cm		2300	12 to 22 cm
		2800	
21 cm		2400	12 to 24 cm
		3100	
28 cm		3600	15 to 32 cm

When you use maximum power on several burners at once, position your cookware following the model of your hob as indicated on the illustrations (3.2.1 - 3.2.2 - 3.2.3).

= recommended positioning.

= positioning to avoid.

In this way you will avoid automatic power limitation on one of the burners if positioning is not optimal.

4



### 4.1 SWITCHING ON - STOPPING

Press the key corresponding to the required burner.

A 0 and a beep indicate that the cooking zone is on. You can adjust the required power of the burner selected. If you do not set the power level, the cooking zone will be switched off automatically (4.1.1).

#### Stopping a zone:

Keep the key corresponding to the required burner pressed down.

A long beep sounds and the display switches off or the "H" symbol (residual heat) appears.

### 4.2 SETTING THE POWER

Press + or - to adjust the power from 1 to 9 then P (4.2.1) (P=maximum power).

When switching on, you can move directly to maximum power P by pressing the - button (4.2.2).

For models , the total available power ( $\leq 4.6\text{kW}$ ) is distributed between the different cooking zones. When a high power on one burner is demanded, the power of the other cooking zones is restricted, as shown below:

- Models :

When maximum power is activated on a burner, the power of the other burners may be adjusted between 1 and 5 only.

When a burner is at power 9, the power of the other burners may be adjusted between 1 and 7 only.

- Model :

When maximum power is activated on a burner, the power of the other burners may be adjusted between 1 and 4 only.

When a burner is at power 9, the power of the other burners may be adjusted between 1 and 5 only.

When a burner is at power 8, the power of the other burners may be adjusted between 1 and 6 only.

### 4.3 SETTING THE TIMER

Each cooking zone has its own timer which can be adjusted up to 99 minutes. It can be used as soon as the cooking zone concerned is turned on.

Press successively on to select the cooking zone on which you want to apply the timer. The timer's LED is highlighted.

Then press + or - to set the time. It is possible to directly access 99 minutes by pressing the - key from the beginning (4.3.2).

When the cooking is finished, 0 is displayed and a beep sounds for around 20 seconds. To deactivate it, press any key.

To stop the timer manually, hold + and - down at the same time or return to 0 using the - button.



#### 4.4 CHILD SAFETY



Your hob has a child safety device which locks the controls when the hob is not in use or when it is being used for cooking. Due to safety reasons, the ① keys remain active and authorise the heating zones to be switched off even when locked.

##### Locking:

Press . The LED above the lock lights up and a beep confirms your operation (4.4.1).

The display of cooking zones in operation alternately indicates power and the locking symbol  (4.4.2).



##### Unlocking:

Press  until the locking symbol  disappears and a beep confirms your operation.

##### CLEAN LOCK function:

The Clean Lock function permits the temporary locking of your hob while it is being cleaned.

To activate the Clean Lock function, press briefly

on . The LED above the lock flashes and a beep confirms your operation. After around 1 minute, locking is automatically deactivated. Two beeps will sound and the light will switch off. You can stop the Clean Lock function at any time by holding down the  button.

#### 4.5 SAFETY PRECAUTIONS AND RECOMMENDATIONS

##### Residual heat:

After intensive use, the cooking zone that you have just used can remain hot for several minutes.

The symbol **H** is displayed during this period (4.5.1).

Avoid touching the areas concerned during this time.

##### Anti-overheat protection:

Each cooking zone has a safety sensor that constantly monitors the temperature of the bottom of the cookware. In the event that empty cookware is left on a cooking zone that is switched on, the hob automatically lowers the power output and thus limits any risk of damage.

##### Protection against overflows:

A special display (symbol ) , a sound signal, followed with the hob switching off, may be triggered in the following cases:

- Overflow that spills onto the buttons (4.5.2)
- Damp towel placed over the buttons.
- Metallic object placed on the buttons (4.5.3).  
Remove the object or clean and dry the touch controls, then restart cooking.

##### Auto-stop:

Your hob has an auto-stop device, which automatically stops any cooking zone which remains switched on for an excessive length of time (between 1 and 10 hours depending on the power used).

If this safety system is triggered, the cut-off to the cooking zone is shown with the "A" display on the control panel and a beep sounds for about 2 minutes. Simply press any of the buttons to stop this.

 Sounds which are similar to those of a clock mechanism may be given off.

These noises occur when the hob is working. They disappear or reduce depending on the heating configuration. There may also be whistling sounds depending on the model and quality of your cookware. The noises described are normal. They are related to induction technology and do not indicate a problem.

##### Advice on how to save energy

When cooking with the grill or empty cookware, we recommend that you do not use maximum power.

## 5



For light dirt, use a disinfectant sponge. Thoroughly moisten the zone to be cleaned with hot water, then wipe off (5).

For a build-up of baked-on dirt or sweet overflows, use a disinfectant sponge and/or a special glass scraper. Thoroughly moisten the zone to be cleaned with hot water. Use a scraper for glass to remove the large bits, finish off with a disinfectant sponge, and then wipe off.

For rings and hard water residue, apply warm white vinegar to the stain, leave on, then wipe with a soft cloth.

For shiny metal streaks or weekly maintenance, use a special vitroceraamic glass product.

**Important note:** do not use any powders or abrasive sponges. Use creams and special delicate glassware sponges.

## 6



### 6.1 DURING INITIAL USE:

- **An indicator light appears.** This is normal. It will go away after 30 seconds.
- **Your installation blows a fuse or one side only of the hob works.** The electrical connection of your hob is incorrect. Check its compliance (see connection chapter 1.3).
- **The hob smells the first few times it is used for cooking.** The appliance is new. Heat up each ring for half an hour with a saucepan full of water.

### 6.2 WHEN POWERING ON:

**The hob does not work and the indicator lights on the control panel are not on.**

The appliance is not receiving electricity. The electrical supply is defective or the connection is incorrect. Inspect the electrical circuit breaker and fuses.

- **The hob does not work and another message is displayed.** The electronic board is functioning poorly. Call the After-Sales Service Department.

- **The hob does not work,** the symbol  is displayed. Unlock the child safety device (see connection chapter 4.4).
- **Error code F9:** voltage less than 170 V
- **Error code F0:** voltage less than 5°C

### 6.3 DURING USE:

- **The hob has stopped working. The symbol  is displayed and there is a sound signal.**

There was an overflow or an object is in contact with the control panel. Clean or remove the object, then begin cooking again.

- **Code F7 is displayed.**

The electronic circuits have overheated. Check the hob's ventilation (see chapter on fitting 1.2).

- **During operation of a heating zone, the keypad display continues to flash.**

The cookware used is not compatible with induction or its size is not suitable for the burner (see chapter 3).

- **The cookware makes noise and your hob clicks during cooking** (see chapter on Safety precautions and recommendations 4.5).

This is normal with some types of cookware. This is caused by the transfer of energy from the hob to the cookware.

- **The fan continues to function after your hob is turned off.**

This is normal. It cools the electronic parts.

- **In the event of persistent malfunction.**

Switch off your hob for 1 minute. If the problem persists, contact the after-sales service.

**Protecting the environment**

This symbol indicates that this product should not be treated as household waste.

Your appliance also contains a great amount of recyclable material. It is marked with this symbol to indicate that used appliances must be disposed of in certified collection points.

Contact your town hall or your retailer for the used appliance collection points closest to your home. This way, the appliance recycling organised by your manufacturer will be done under the best possible conditions, in compliance with European Directive on Waste Electrical and Electronic Equipment.

This appliance's packing materials are also recyclable. Help recycle it and protect the environment by dropping it off in the municipal receptacles provided for this purpose.

We thank you for your help in protecting the environment.

Estimado cliente:

Le agradecemos la confianza que ha depositado en nosotros al adquirir este producto **BRANDT**.

Hemos diseñado y fabricado este producto pensando en usted, en su modo de vida y en sus necesidades para poder satisfacer mejor sus expectativas, animados por el espíritu innovador y la pasión que nos caracteriza desde hace más de 60 años.

Para responder a todas sus necesidades, tenemos un servicio de atención al cliente a su disposición que atenderá todas sus preguntas y sugerencias.

También disponemos de una página web [www.brandt.com](http://www.brandt.com) donde encontrará todos nuestros productos, así como información útil y complementaria.

**En BRANDT nos congratulamos de acompañarle en su día a día y le deseamos que disfrute plenamente de su compra.**



Importante: antes de poner en marcha su aparato, lea atentamente esta guía de instalación y utilización con el fin de familiarizarse más rápidamente con su funcionamiento.